

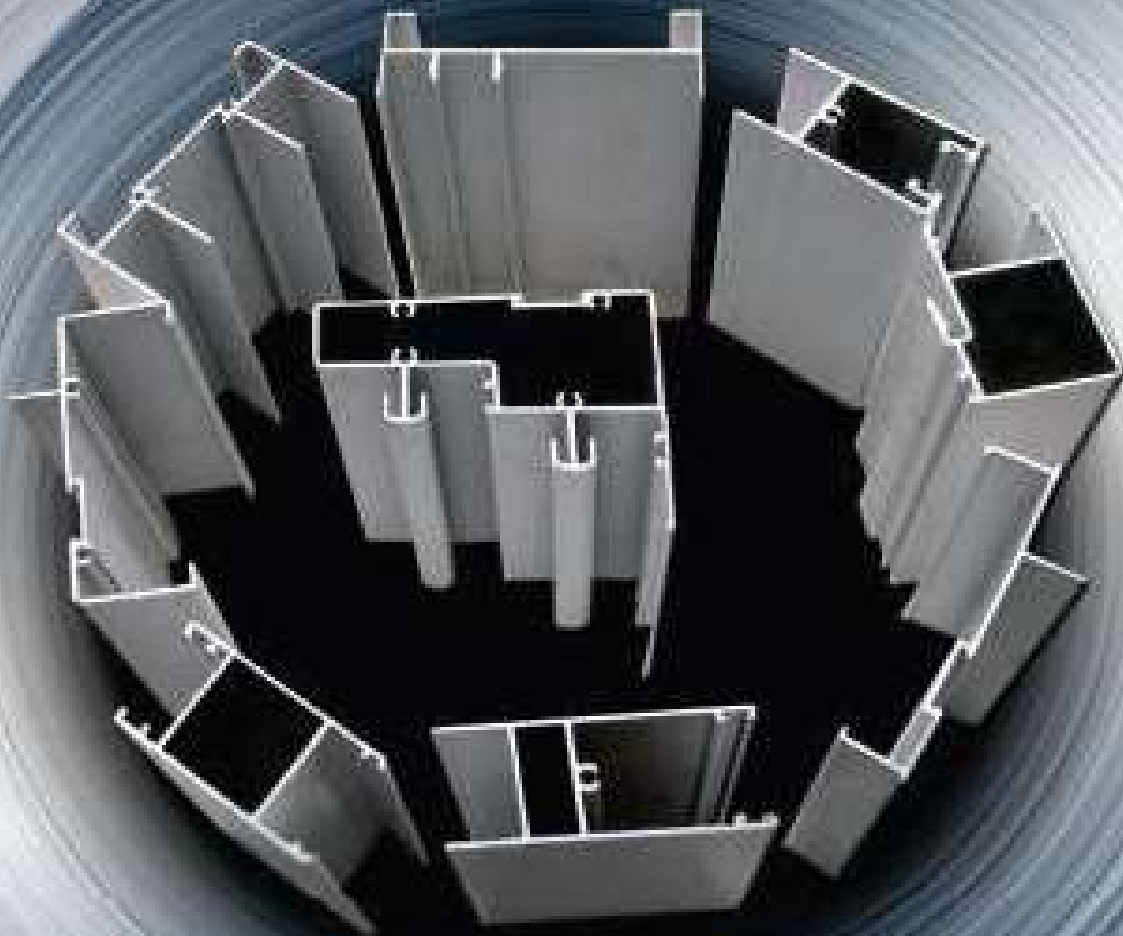

High
Performance
Delivered



Proud to make in India

www.ryextrusion.com

Company

- **Aluminium Alloy Sections:** Manufacture 5mm to 125mm cross sectional diameter profiles for industrial and commercial use
- **Mumbai:** Operate three million dollar 100,000 sqft automated manufacturing facility located near Mumbai
- **Data Driven–Quality Focused:** Practice precision manufacturing using latest technology to provide best quality



Product and Services

- **50 Industrial SKUs:** Serve a mix of HVAC, pharmaceutical, furniture, marketing displays and electrical panel industry
- **445 Commercial SKUs:** Supply doors, windows and construction industry with 90 profiles in 5 different weight ranges
- **Value Added Services:** Provide additional services such as die design, die development, color anodizing, customized size etc.

We produce world class aluminium profiles using precision manufacturing technology

PHARMA PROFILE'S

136

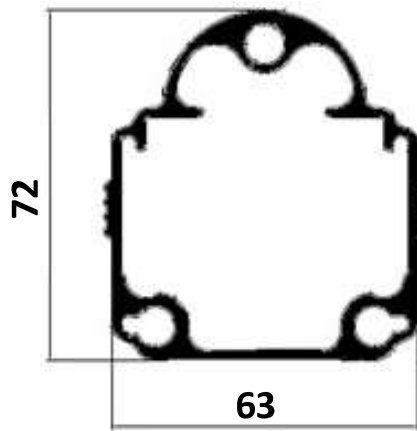

Wt: 2.200 KG/M

137

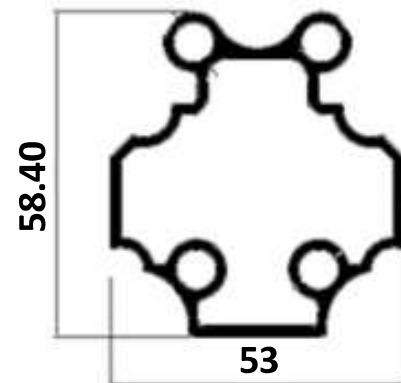

Wt: 1.379 KG/M

182

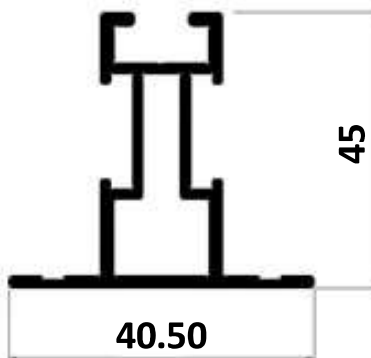

Wt: 0.730 KG/M

879

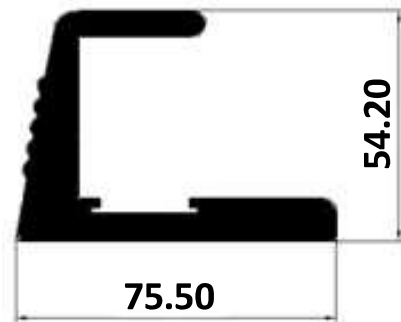

Wt: 3.260-3.600 KG/M

9991

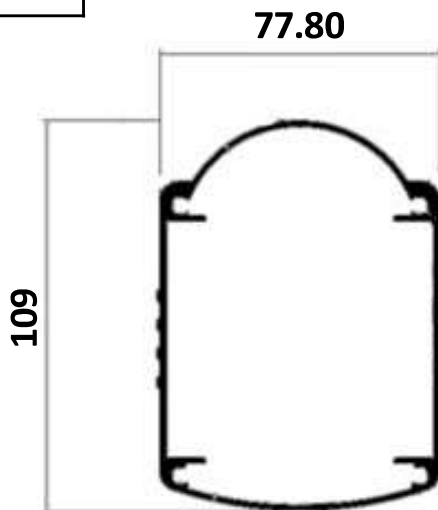

Wt: 2.260 KG/M

9992

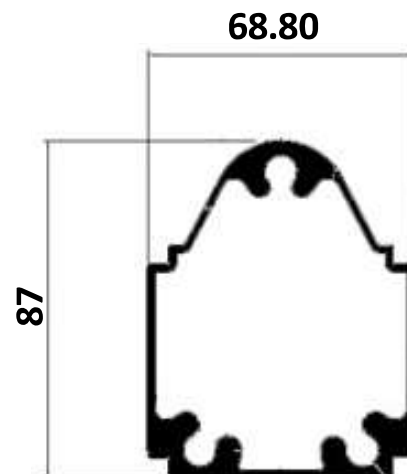

Wt: 2.740 KG/M

9471

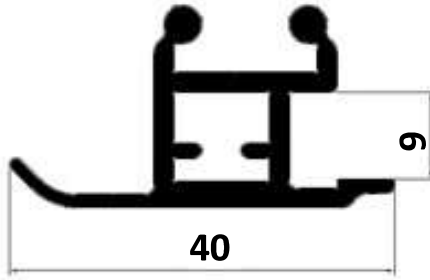

Wt: 0.241 KG/M

9472

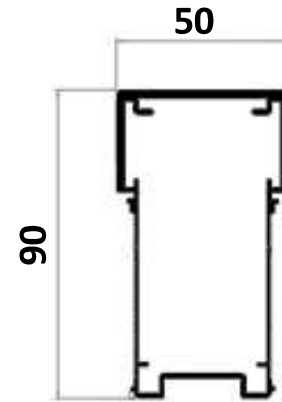

Wt: 1.560 KG/M

9473

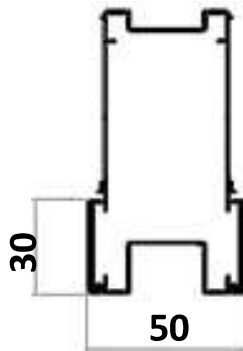

Wt: 1.560 KG/M

9474

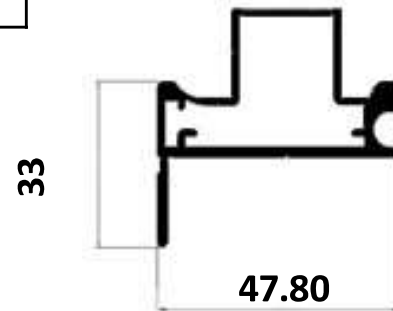

Wt: 1.020 KG/M

9991

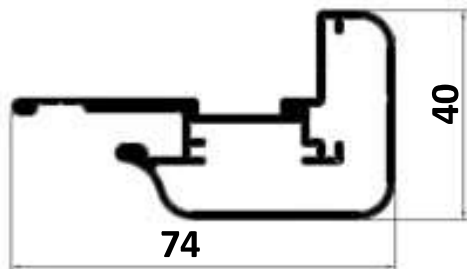

Wt: 1.100 KG/M

9992

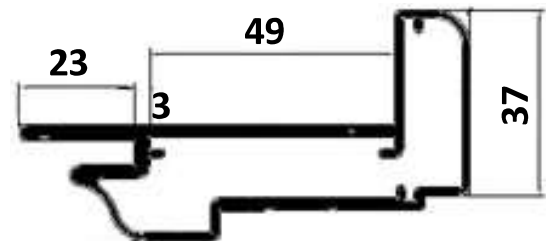

Wt: 1.530 KG/M

9001-BM1

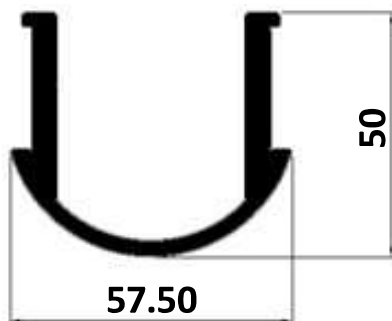

Wt: 2.260 KG/M

9001-BM2

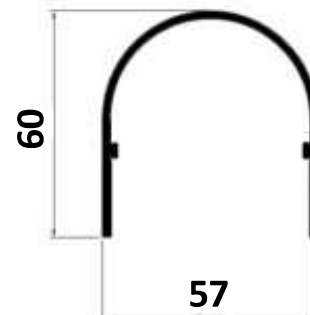

Wt: 0.930 KG/M