

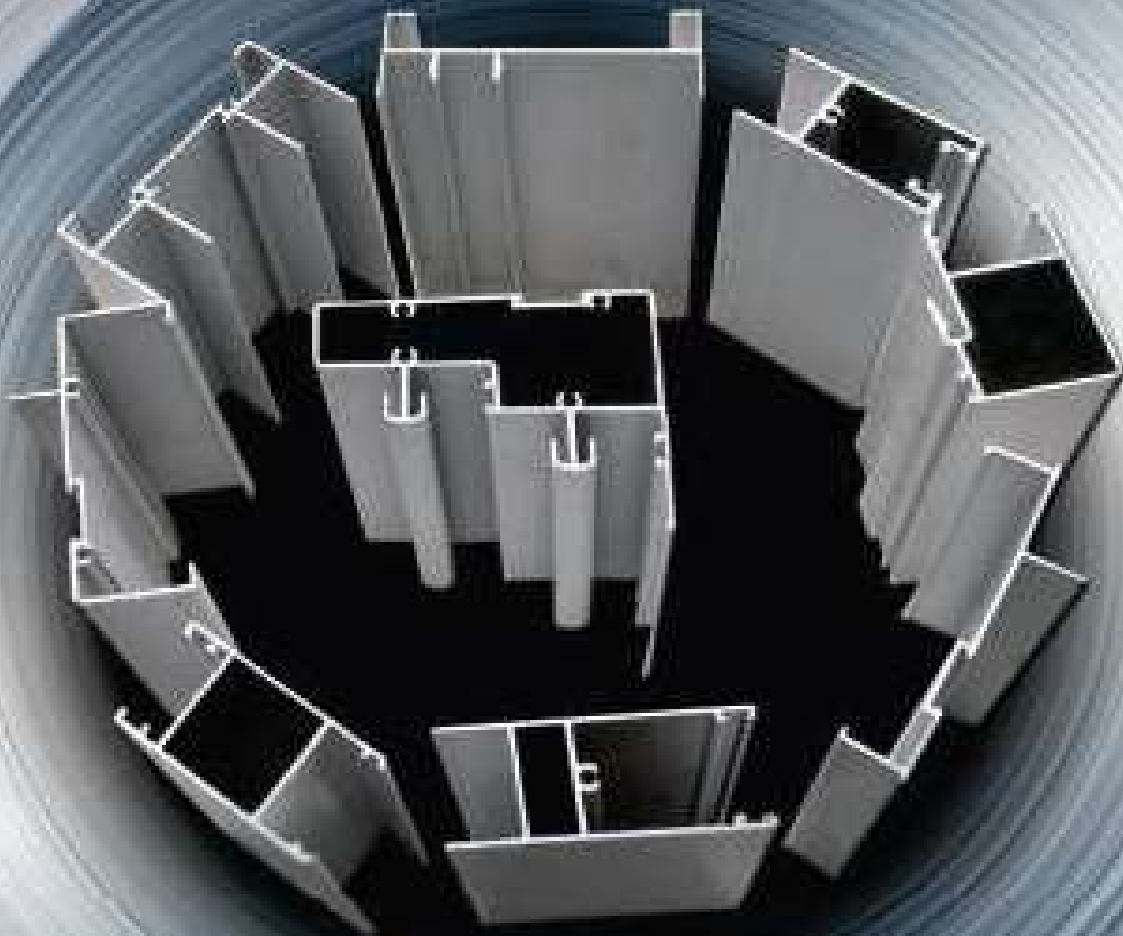

High
Performance
Delivered



Proud to make in India

www.ryextrusion.com

Company

- **Aluminium Alloy Sections:** Manufacture 5mm to 125mm cross sectional diameter profiles for industrial and commercial use
- **Mumbai:** Operate three million dollar 100,000 sqft automated manufacturing facility located near Mumbai
- **Data Driven–Quality Focused:** Practice precision manufacturing using latest technology to provide best quality



Product and Services

- **50 Industrial SKUs:** Serve a mix of HVAC, pharmaceutical, furniture, marketing displays and electrical panel industry
- **445 Commercial SKUs:** Supply doors, windows and construction industry with 90 profiles in 5 different weight ranges
- **Value Added Services:** Provide additional services such as die design, die development, color anodizing, customized size etc.

We produce world class aluminium profiles using precision manufacturing technology

AUTOMATION PROFILE'S

1501

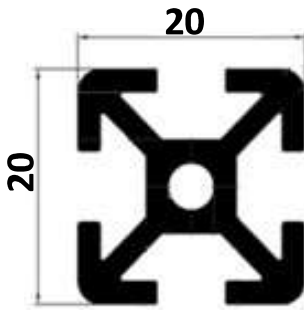

Wt: 0.530KG/M

1502

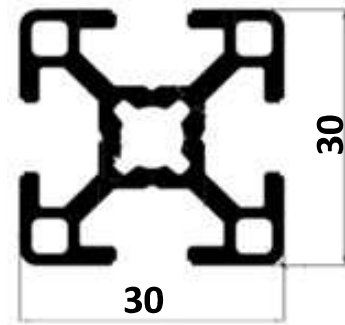

Wt: 0.850KG/M

1503

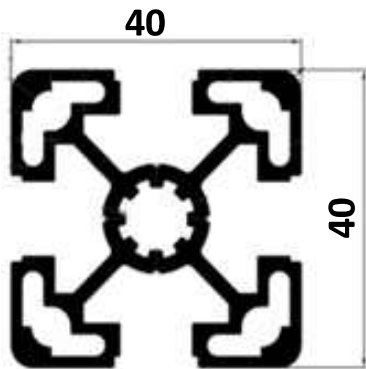

Wt: 1.500 KG/M

1504

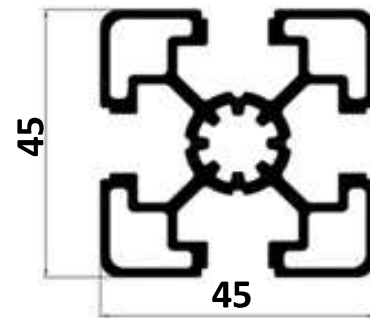

Wt: 1.650 KG/M

1505

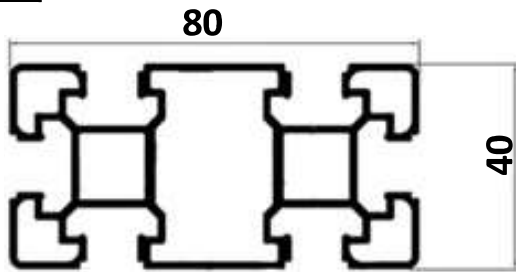

Wt: 1.900KG/M

1506

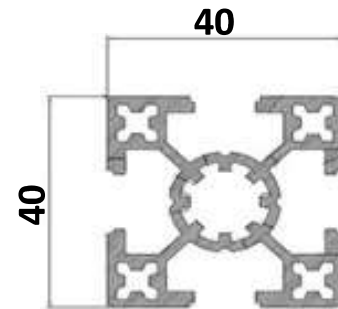

Wt: 1.410KG/M

1507

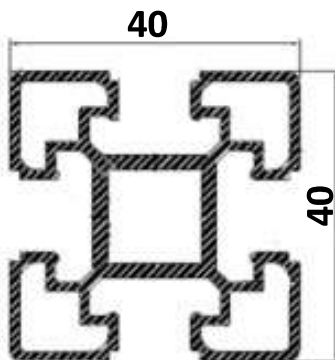

Wt: 1.100-1.230KG/M

1508

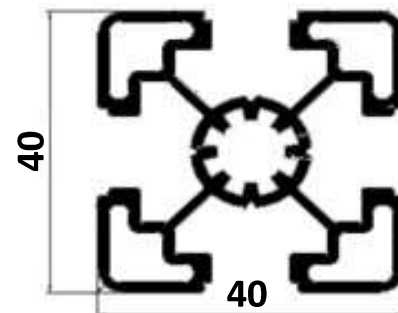

Wt: 1.277 KG/M

1509

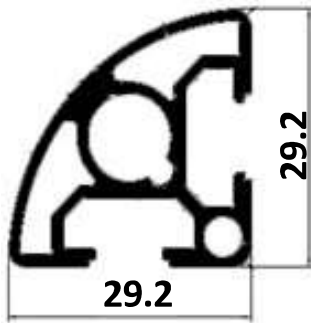

Wt: 0.520 KG/M

1510

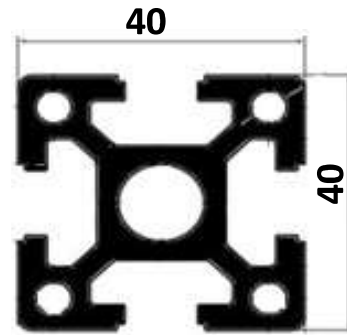

Wt: 1.960 KG/M

1511

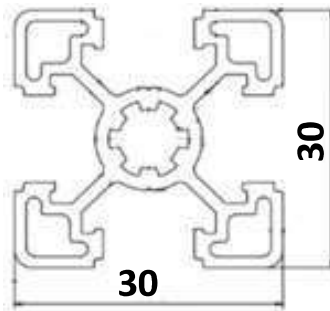

Wt: 0.725 KG/M

1512

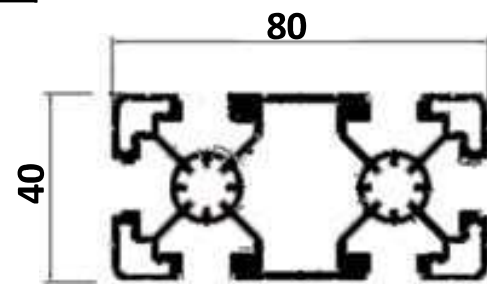

Wt: 2.578 KG/M

1513

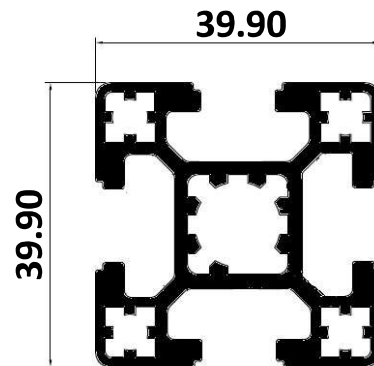

Wt: 1.530 KG/M